

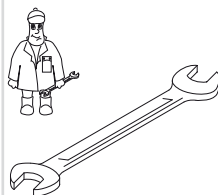

Gebr. Becker GmbH
Hölker Feld 29-31
D-42279 Wuppertal

Wartung
Maintenance
Entretien
Manutenzione
Mantenimiento



	Pos.	Menge ²⁾ Quantity Quantité Quantità Cantidad	Bestell-Nr. Ident No. No. Identification No. Identificazione No. de pedido	Bezeichnung Description Designation Designazione Descripción
T 4.10DV	24	SATZ (KIT)	901327 00007	Schieber, Rotor Vane, Palette, Empujador
	72	1	909518 00000	Filterpatrone, Filter cartridge, Cartouche Filtrante, Cartuccia filtro, Cartucho de filtro
	74	1	909554 00000	Filterpatrone, Filter cartridge, Cartouche Filtrante, Cartuccia filtro, Cartucho de filtro
T 4.16 DV	24	SATZ (KIT)	901347 00007	Schieber, Rotor Vane, Palette, Empujador
	72	1	909519 00000	Filterpatrone, Filter cartridge, Cartouche Filtrante, Cartuccia filtro, Cartucho de filtro
	74	1	909542 00000	Filterpatrone, Filter cartridge, Cartouche Filtrante, Cartuccia filtro, Cartucho de filtro

²⁾ erforderliche Bestellmenge / necessary order quantity / quantité nécessaire / quantità di ordinazione necessari / cantidad necesario

www.becker-international.com



Ersatzteilliste
Spare parts list
Liste de pièces de rechange
Listino pezzi di ricambio
Lista de piezas de recambio
Lista de peças sobresselentes
Reserveonderdelenlijst
Reservedelsliste
Reservdelslista

Reservedelsliste
Varaosaluettelo
Wykaz części zamiennych
Seznam náhradních dílů
Tartalékalkatrész lista
Κατάλογος ανταλλακτικών
Перечень запасных частей
备用零件目录
スペアパーツリスト

T 4.10 DV
T 4.16 DV



28000027303 11/2006

SERVICE

BECKER
D-42279 Wuppertal
www.becker-international.com

CE

year

No.

type

frequency Hz

speed min⁻¹

power required kW

inlet capacity m³/h

pressure + mbar

vacuum - mbar

Made in Germany

Index
Option

(D) Service:

Tel: +49 (0)202 697-171

Fax: +49 (0)202 64 44 74

E-Mail: info@becker-international.com

www.becker-international.com

www.becker-international.com

Index	Pos.	Bestell Nr.	Beschreibung 
T 4.10 DV	15	020000 16200	KOLBEN
	16	016800 05000	SPANNSCHEIBE
	17	911001 00000	STAR-TOLERANZRING
	18	949203 00000	ZAHNSCHEIBE
	19	945320 00000	INNENSECHSKANTSCHRAUBE
	21	000100 16200	GEHÄUSE
	23	945319 00000	INNENSECHSKANTSCHRAUBE
	24	901327 00007	SCHIEBER-KOHL E (SATZ)
	28	000700 16200	SEITENDECKEL
	29	945364 00000	INNENSECHSKANTSCHRAUBE
	30	008901 16200	DICHTUNG
	61	004800 27300	FILTERDECKEL
	67	009000 16300	ANPRESSFEDER
	69	952009 00000	SPANNHÜLSE
	72	909518 00000	FILTERPATRONE (1x) ¹⁾
	74	909554 00000	PATRONE-“C“-ABSCHIEDER 35015 (1x) ¹⁾
	76	945364 00000	INNENSECHSKANTSCHRAUBE
	77	948021 00000	DICHTRING
	78	913161 00000	O-RING
	83	006800 27300	GERÄTEHAUBE
	84	060901 16300	DÄMPFUNGSSTREIFEN
	85	741310 50000	GUMMIPUFFER
	86	949402 00000	UNTERLEGSCHIEBE
	87	947001 00000	SECHSKANTMUTTER
	88	006801 27400	FRONTHAUBE
	89	741309 00000	GUMMIPUFFER
	90	945318 00000	INNENSECHSKANTSCHRAUBE
	91	951922 00000	GUMMIFORMTEIL
94	015100 27300	MOTORFUSS	
95	951921 00000	GUMMIFORMTEIL	
96	068000 27600	DISTANZSTÜCK	
97	945363 00000	INNENSECHSKANTSCHRAUBE	
98	949451 00000	UNTERLEGSCHIEBE	
102	968104 00000	GUMMI-DISTANZSTÜCK	
103	029600 16300	BOLZEN	
126	736000 99613	VAKUUMREGULIERVENTIL	
127	728002 99611	DRUCKREGULIERVENTIL	

¹⁾ erforderliche Bestellmenge / Wartung

T 4.10 DV (1~) Ausführung - Einphasenwechselstrom

OPTIONAL

Abweichende Positionen zum Standardgerät - siehe Anhang (Zeichnungsrückseite) 

Index	Pos.	Bestell Nr.	Beschreibung 
T 4.16 DV	15	020000 16300	KOLBEN
	16	016800 16300	SPANNSCHEIBE
	17	911009 00000	STAR-TOLERANZRING
	18	949203 00000	ZAHNSCHEIBE
	19	945320 00000	INNENSECHSKANTSCHRAUBE
	21	000105 16300	GEHÄUSE
	23	945321 00000	INNENSECHSKANTSCHRAUBE
	24	901347 00007	SCHIEBER-KOHL E (SATZ)
	28	000705 16300	SEITENDECKEL
	29	945372 00000	INNENSECHSKANTSCHRAUBE
	30	008901 16300	DICHTUNG
	61	004800 27400	FILTERDECKEL
	67	009000 16300	ANPRESSFEDER
	69	952009 00000	SPANNHÜLSE
	72	909519 00000	FILTERPATRONE (1x) ¹⁾
	74	909542 00000	PATRONE-“C“-ABSCHIEDER C 63 (1x) ¹⁾
	76	945325 00000	INNENSECHSKANTSCHRAUBE
	77	948021 00000	DICHTRING
	78	913161 00000	O-RING
	83	006800 27400	GERÄTEHAUBE
	84	060901 16300	DÄMPFUNGSSTREIFEN
	85	741310 50000	GUMMIPUFFER
	86	949402 00000	UNTERLEGSCHIEBE
	87	947001 00000	SECHSKANTMUTTER
	88	006801 27400	FRONTHAUBE
	89	741310 90000	GUMMIPUFFER
	90	945318 00000	INNENSECHSKANTSCHRAUBE
	91	951922 00000	GUMMIFORMTEIL
94	015100 27400	MOTORFUSS	
95	951921 00000	GUMMIFORMTEIL	
96	068000 27600	DISTANZSTÜCK	
97	945323 00000	INNENSECHSKANTSCHRAUBE	
98	949451 00000	UNTERLEGSCHIEBE	
102	968104 00000	GUMMI-DISTANZSTÜCK	
103	029600 16300	BOLZEN	
126	736000 99613	VAKUUMREGULIERVENTIL	
127	728002 99611	DRUCKREGULIERVENTIL	

¹⁾ erforderliche Bestellmenge / Wartung

T 4.16 DV (1~) Ausführung - Einphasenwechselstrom

OPTIONAL

Abweichende Positionen zum Standardgerät - siehe Anhang (Zeichnungsrückseite) 

Index	Pos.	Ident No.	Description 
T 4.10 DV	15	020000 16200	ROTOR
	16	016800 05000	CLAMPING DISC
	17	911001 00000	STAR-TOLERANCE-RING
	18	949203 00000	TOOTHED SPRING WASHER
	19	945320 00000	SOCKET HEAD SCREW
	21	000100 16200	PUMP BODY
	23	945319 00000	SOCKET HEAD SCREW
	24	901327 00007	CARBON VANES (KIT)
	28	000700 16200	LID
	29	945364 00000	SOCKET HEAD SCREW
	30	008901 16200	GASKET
	61	004800 27300	FILTER COVER
	67	009000 16300	BLADE SPRING
	69	952009 00000	LOCATING PIN
	72	909518 00000	FILTER CARTRIDGE (1x)¹⁾
	74	909554 00000	FILTER CARTRIDGE 35015 (1x)¹⁾
	76	945364 00000	SOCKET HEAD SCREW
	77	948021 00000	SEALING RING
	78	913161 00000	O-RING
	83	006800 27300	PROTECTING HOOD
	84	060901 16300	ELASTIC PAD
	85	741310 50000	RUBBER BUFFER
	86	949402 00000	WASHER
	87	947001 00000	HEX.NUT
	88	006801 27400	PROTECTING HOOD (FRONT)
	89	741309 00000	RUBBER BUFFER
	90	945318 00000	SOCKET HEAD SCREW
91	951922 00000	RUBBER ELEMENT	
94	015100 27300	FOOT	
95	951921 00000	RUBBER ELEMENT	
96	068000 27600	SPACING COLLAR	
97	945363 00000	SOCKET HEAD SCREW	
98	949451 00000	WASHER	
102	968104 00000	RUBBER SLEEVE	
103	029600 16300	BOLT	
126	736000 99613	VACUUM REGULATING VALVE	
127	728002 99611	PRESSURE REGULATING VALVE	

¹⁾ necessary order quantity / maintenance

T 4.10 DV (1~) Design - single-phase AC

OPTIONAL

Items different from standard appliance see appendix (back of drawing) 

Index	Pos.	Ident No.	Description 
T 4.16 DV	15	020000 16300	ROTOR
	16	016800 16300	CLAMPING DISC
	17	911009 00000	STAR-TOLERANCE-RING
	18	949203 00000	TOOTHED SPRING WASHER
	19	945320 00000	SOCKET HEAD SCREW
	21	000105 16300	PUMP BODY
	23	945321 00000	SOCKET HEAD SCREW
	24	901347 00007	CARBON VANES (KIT)
	28	000705 16300	LID
	29	945372 00000	SOCKET HEAD SCREW
	30	008901 16300	GASKET
	61	004800 27400	FILTER COVER
	67	009000 16300	BLADE SPRING
	69	952009 00000	LOCATING PIN
	72	909519 00000	FILTER CARTRIDGE (1x)¹⁾
	74	909542 00000	FILTER CARTRIDGE C 63 (1x)¹⁾
	76	945325 00000	SOCKET HEAD SCREW
	77	948021 00000	SEALING RING
	78	913161 00000	O-RING
	83	006800 27400	PROTECTING HOOD
	84	060901 16300	ELASTIC PAD
	85	741310 50000	RUBBER BUFFER
	86	949402 00000	WASHER
	87	947001 00000	HEX.NUT
	88	006801 27400	PROTECTING HOOD (FRONT)
	89	741310 90000	RUBBER BUFFER
	90	945318 00000	SOCKET HEAD SCREW
91	951922 00000	RUBBER ELEMENT	
94	015100 27400	FOOT	
95	951921 00000	RUBBER ELEMENT	
96	068000 27600	SPACING COLLAR	
97	945323 00000	SOCKET HEAD SCREW	
98	949451 00000	WASHER	
102	968104 00000	RUBBER SLEEVE	
103	029600 16300	BOLT	
126	736000 99613	VACUUM REGULATING VALVE	
127	728002 99611	PRESSURE REGULATING VALVE	

¹⁾ necessary order quantity / maintenance

T 4.16 DV (1~) Design - single-phase AC

OPTIONAL

Items different from standard appliance see appendix (back of drawing) 

Index	Pos.	No. Identification	Designation 
T 4.10 DV	15	020000 16200	PISTON
	16	016800 05000	DISQUE DE SERRAGE
	17	911001 00000	BAGUE STAR
	18	949203 00000	DENT DISQUE
	19	945320 00000	VIS HEXAGONALE INTERNE
	21	000100 16200	CORP DE POMPE
	23	945319 00000	VIS HEXAGONALE INTERNE
	24	901327 00007	PALETTE DE CHARBON (KIT)
	28	000700 16200	COUVERCLE
	29	945364 00000	VIS HEXAGONALE INTERNE
	30	008901 16200	JOINT
	61	004800 27300	COUVERCLE DU FILTRE
	67	009000 16300	RESSORT-JAME
	69	952009 00000	DOVILLE DE ETRAGE
	72	909518 00000	CARTOUCHE FILTRANTE (1x) ¹⁾
	74	909554 00000	CARTOUCHE FILTRANTE 35015 (1x) ¹⁾
	76	945364 00000	VIS HEXAGONALE INTERNE
	77	948021 00000	JOINT
	78	913161 00000	ANNEAU-O
	83	006800 27300	CARTER PROTECTEUR
	84	060901 16300	AMORTISSEUR
	85	741310 50000	AMORTISSEUR EN CAOUTCHOUC
	86	949402 00000	RONDELLE
	87	947001 00000	ECROU A 6PANS
	88	006801 27400	CARTER PROTECTEUR
	89	741309 00000	AMORTISSEUR EN CAOUTCHOUC
	90	945318 00000	VIS HEXAGONALE INTERNE
	91	951922 00000	ELEMENT EN CAOUTCHOUC
94	015100 27300	PIED	
95	951921 00000	ELEMENT EN CAOUTCHOUC	
96	068000 27600	DONILLE D'ECARMENT	
97	945363 00000	VIS HEXAGONALE INTERNE	
98	949451 00000	RONDELLE	
102	968104 00000	PIECE D'ECARTEMENT CAOUTCHOUC	
103	029600 16300	BOULON	
126	736000 99613	SOUPAPE REGLAGE VIDE	
127	728002 99611	SOUPAPE REGLAGE PRESS.	

¹⁾ quantité nécessaire / entretien

T 4.10 DV (1~) Fabrication - AC monophasé

EN OPTION

Articles divergents vis-à-vis de l'appareil standard, voir annexe (dos du dessin / du plan) 

Index	Pos.	No. Identification	Designation 
T 4.16 DV	15	020000 16300	PISTON
	16	016800 16300	DISQUE DE SERRAGE
	17	911009 00000	BAGUE STAR
	18	949203 00000	DENT DISQUE
	19	945320 00000	VIS HEXAGONALE INTERNE
	21	000105 16300	CORP DE POMPE
	23	945321 00000	VIS HEXAGONALE INTERNE
	24	901347 00007	PALETTE DE CHARBON (KIT)
	28	000705 16300	COUVERCLE
	29	945372 00000	VIS HEXAGONALE INTERNE
	30	008901 16300	JOINT
	61	004800 27400	COUVERCLE DU FILTRE
	67	009000 16300	RESSORT-JAME
	69	952009 00000	DOVILLE DE ETRAGE
	72	909519 00000	CARTOUCHE FILTRANTE (1x) ¹⁾
	74	909542 00000	CARTOUCHE FILTRANTE C 63 (1x) ¹⁾
	76	945325 00000	VIS HEXAGONALE INTERNE
	77	948021 00000	JOINT
	78	913161 00000	ANNEAU-O
	83	006800 27400	CARTER PROTECTEUR
	84	060901 16300	AMORTISSEUR
	85	741310 50000	AMORTISSEUR EN CAOUTCHOUC
	86	949402 00000	RONDELLE
	87	947001 00000	ECROU A 6PANS
	88	006801 27400	CARTER PROTECTEUR
	89	741310 90000	AMORTISSEUR EN CAOUTCHOUC
	90	945318 00000	VIS HEXAGONALE INTERNE
	91	951922 00000	ELEMENT EN CAOUTCHOUC
94	015100 27400	PIED	
95	951921 00000	ELEMENT EN CAOUTCHOUC	
96	068000 27600	DONILLE D'ECARMENT	
97	945323 00000	VIS HEXAGONALE INTERNE	
98	949451 00000	RONDELLE	
102	968104 00000	PIECE D'ECARTEMENT CAOUTCHOUC	
103	029600 16300	BOULON	
126	736000 99613	SOUPAPE REGLAGE VIDE	
127	728002 99611	SOUPAPE REGLAGE PRESS.	

¹⁾ quantité nécessaire / entretien

T 4.16 DV (1~) Fabrication - AC monophasé

EN OPTION

Articles divergents vis-à-vis de l'appareil standard, voir annexe (dos du dessin / du plan) 

Index	Pos.	No. Identificazione	Designazione
T 4.10 DV	15	020000 16200	ROTORE
	16	016800 05000	DISCO DI FISSAGGIO
	17	911001 00000	STAR-ANELLO TOLLERANZA
	18	949203 00000	DISCO A DENTE
	19	945320 00000	VITE ESAGONALE INTERNA
	21	000100 16200	CARCASSA
	23	945319 00000	VITE ESAGONALE INTERNA
	24	901327 00007	PALETTE DI CHARBONE (KIT)
	28	000700 16200	COPERCHIO
	29	945364 00000	VITE ESAGONALE INTERNA
	30	008901 16200	GUARNIZIONE
	61	004800 27300	COPERCHIO FILTRO
	67	009000 16300	MOLLA
	69	952009 00000	SPINE DI RISCONTRO
	72	909518 00000	CARTUCCIA FILTRO (1x)¹⁾
	74	909554 00000	CARTUCCIA FILTRO 35015 (1x)¹⁾
	76	945364 00000	VITE ESAGONALE INTERNA
	77	948021 00000	ANELLO GUARNIZIONE
	78	913161 00000	ANELLO-O
	83	006800 27300	CAPOTO DI PROTEZIONE
	84	060901 16300	AMORTIZZATORE
	85	741310 50000	AMMORTIZZATORE IN GOMMA
	86	949402 00000	RONDELLA
	87	947001 00000	DADO ESAGONALE
	88	006801 27400	CARTER DI PROTEZIONE
	89	741309 00000	AMMORTIZZATORE IN GOMMA
	90	945318 00000	VITE ESAGONALE INTERNA
	91	951922 00000	ELEMENTO IN GOMMA
94	015100 27300	PIEDE	
95	951921 00000	ELEMENTO IN GOMMA	
96	068000 27600	BOCCOLA DISTANZIATRICE	
97	945363 00000	VITE ESAGONALE INTERNA	
98	949451 00000	RONDELLA	
102	968104 00000	PEZZO DI SCOSTAM. IN GOMMA	
103	029600 16300	BULLONE	
126	736000 99613	VALVOLA REGOLAZIONE VUOTO	
127	728002 99611	VALVOLA REGOL. PRESS.	

¹⁾ quantità di ordinazione necessari / manutenzione

T 4.10 DV (1~) Modello - AC monofase

Vedere allegato (retro del disegno) per le posizioni divergenti dall'apparecchio standard

OPZIONALE

Index	Pos.	No. Identificazione	Designazione
T 4.16 DV	15	020000 16300	ROTORE
	16	016800 16300	DISCO DI FISSAGGIO
	17	911009 00000	STAR-ANELLO TOLLERANZA
	18	949203 00000	DISCO A DENTE
	19	945320 00000	VITE ESAGONALE INTERNA
	21	000105 16300	CARCASSA
	23	945321 00000	VITE ESAGONALE INTERNA
	24	901347 00007	PALETTE DI CHARBONE (KIT)
	28	000705 16300	COPERCHIO
	29	945372 00000	VITE ESAGONALE INTERNA
	30	008901 16300	GUARNIZIONE
	61	004800 27400	COPERCHIO FILTRO
	67	009000 16300	MOLLA
	69	952009 00000	SPINE DI RISCONTRO
	72	909519 00000	CARTUCCIA FILTRO (1x)¹⁾
	74	909542 00000	CARTUCCIA FILTRO C 63 (1x)¹⁾
	76	945325 00000	VITE ESAGONALE INTERNA
	77	948021 00000	ANELLO GUARNIZIONE
	78	913161 00000	ANELLO-O
	83	006800 27400	CAPOTO DI PROTEZIONE
	84	060901 16300	AMORTIZZATORE
	85	741310 50000	AMMORTIZZATORE IN GOMMA
	86	949402 00000	RONDELLA
	87	947001 00000	DADO ESAGONALE
	88	006801 27400	CARTER DI PROTEZIONE
	89	741310 90000	AMMORTIZZATORE IN GOMMA
	90	945318 00000	VITE ESAGONALE INTERNA
	91	951922 00000	ELEMENTO IN GOMMA
94	015100 27400	PIEDE	
95	951921 00000	ELEMENTO IN GOMMA	
96	068000 27600	BOCCOLA DISTANZIATRICE	
97	945323 00000	VITE ESAGONALE INTERNA	
98	949451 00000	RONDELLA	
102	968104 00000	PEZZO DI SCOSTAM. IN GOMMA	
103	029600 16300	BULLONE	
126	736000 99613	VALVOLA REGOLAZIONE VUOTO	
127	728002 99611	VALVOLA REGOL. PRESS.	

¹⁾ quantità di ordinazione necessari / manutenzione

T 4.16 DV (1~) Modello - AC monofase

Vedere allegato (retro del disegno) per le posizioni divergenti dall'apparecchio standard

OPZIONALE

Index	Pos.	No. De pedido	Descripción	
T 4.10 DV	15	020000 16200	ÉMBOLO	
	16	016800 05000	ARANDELA TENSORA	
	17	911001 00000	ANILLO DE TOLERANCIA STAR	
	18	949203 00000	POLEA DENTADA	
	19	945320 00000	TORNILLO HEXAGONAL INTERIOR	
	21	000100 16200	CARCASA	
	23	945319 00000	TORNILLO HEXAGONAL INTERIOR	
	24	901327 00007	EMPUJADOR DE CARBÓN (KIT)	
	28	000700 16200	TAPA LATERAL	
	29	945364 00000	TORNILLO HEXAGONAL INTERIOR	
	30	008901 16200	JUNTA	
	61	004800 27300	TAPA DE FILTRO	
	67	009000 16300	MUELLE DE PRESIÓN	
	69	952009 00000	CASQUILLO TENSOR	
	72	909518 00000	CARTUCHO DE FILTRO (1x)¹⁾	
	74	909554 00000	CARTUCHO DE FILTRO 35015 (1x)¹⁾	
	76	945364 00000	TORNILLO HEXAGONAL INTERIOR	
	77	948021 00000	ANILLO DE JUNTA	
	78	913161 00000	JUNTA TÓRICA	
	83	006800 27300	CAPERUZA DE APARATO	
	84	060901 16300	TIRAS DE AMORTIGUACIÓN	
	85	741310 50000	AMORTIGUADOR DE GOMA	
	86	949402 00000	ARANDELA	
	87	947001 00000	TUERCA HEXAGONAL	
	88	006801 27400	CAPERUZA FRONTAL	
	89	741309 00000	AMORTIGUADOR DE GOMA	
	90	945318 00000	TORNILLO HEXAGONAL INTERIOR	
91	951922 00000	PIEZA DE ORMA DE GOMA		
94	015100 27300	PIE DE MOTOR		
95	951921 00000	PIEZA DE ORMA DE GOMA		
96	068000 27600	PIEZA DISTANCIADORA		
97	945363 00000	TORNILLO HEXAGONAL INTERIOR		
98	949451 00000	ARANDELA		
102	968104 00000	PIEZA DE GOMA DISTANCIADORA		
103	029600 16300	BULÓN		
126	736000 99613	VÁLVULA REGULADORA DE VACÍO		
127	728002 99611	VÁLVULA REGULADORA DE PRESIÓN		

¹⁾ cantidad necesario / mantenimiento

T 4.10 DV (1~) Versión - AC monofásica

Para posiciones que derivan del aparato standard véase apéndice (lado trasero del plano) 

OPCIONAL

Index	Pos.	No. De pedido	Descripción	
T 4.16 DV	15	020000 16300	ÉMBOLO	
	16	016800 16300	ARANDELA TENSORA	
	17	911009 00000	ANILLO DE TOLERANCIA STAR	
	18	949203 00000	POLEA DENTADA	
	19	945320 00000	TORNILLO HEXAGONAL INTERIOR	
	21	000105 16300	CARCASA	
	23	945321 00000	TORNILLO HEXAGONAL INTERIOR	
	24	901347 00007	EMPUJADOR DE CARBÓN (KIT)	
	28	000705 16300	TAPA LATERAL	
	29	945372 00000	TORNILLO HEXAGONAL INTERIOR	
	30	008901 16300	JUNTA	
	61	004800 27400	TAPA DE FILTRO	
	67	009000 16300	MUELLE DE PRESIÓN	
	69	952009 00000	CASQUILLO TENSOR	
	72	909519 00000	CARTUCHO DE FILTRO (1x)¹⁾	
	74	909542 00000	CARTUCHO-“C“-SEPARADOR C 63 (1x)¹⁾	
	76	945325 00000	TORNILLO HEXAGONAL INTERIOR	
	77	948021 00000	ANILLO DE JUNTA	
	78	913161 00000	JUNTA TÓRICA	
	83	006800 27400	CAPERUZA DE APARATO	
	84	060901 16300	TIRAS DE AMORTIGUACIÓN	
	85	741310 50000	AMORTIGUADOR DE GOMA	
	86	949402 00000	ARANDELA	
	87	947001 00000	TUERCA HEXAGONAL	
	88	006801 27400	CAPERUZA FRONTAL	
	89	741310 90000	AMORTIGUADOR DE GOMA	
	90	945318 00000	TORNILLO HEXAGONAL INTERIOR	
91	951922 00000	PIEZA DE ORMA DE GOMA		
94	015100 27400	PIE DE MOTOR		
95	951921 00000	PIEZA DE ORMA DE GOMA		
96	068000 27600	PIEZA DISTANCIADORA		
97	945323 00000	TORNILLO HEXAGONAL INTERIOR		
98	949451 00000	ARANDELA		
102	968104 00000	PIEZA DE GOMA DISTANCIADORA		
103	029600 16300	BULÓN		
126	736000 99613	VÁLVULA REGULADORA DE VACÍO		
127	728002 99611	VÁLVULA REGULADORA DE PRESIÓN		

¹⁾ cantidad necesario / mantenimiento

T 4.16 DV (1~) Versión - AC monofásica

Para posiciones que derivan del aparato standard véase apéndice (lado trasero del plano) 

OPCIONAL

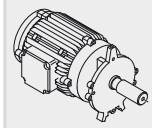

SERVICE ?

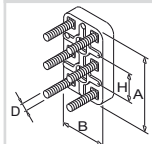
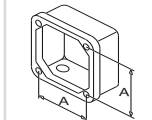
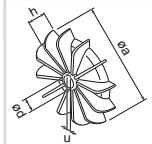

1~

C = ? μ F
U = ? V

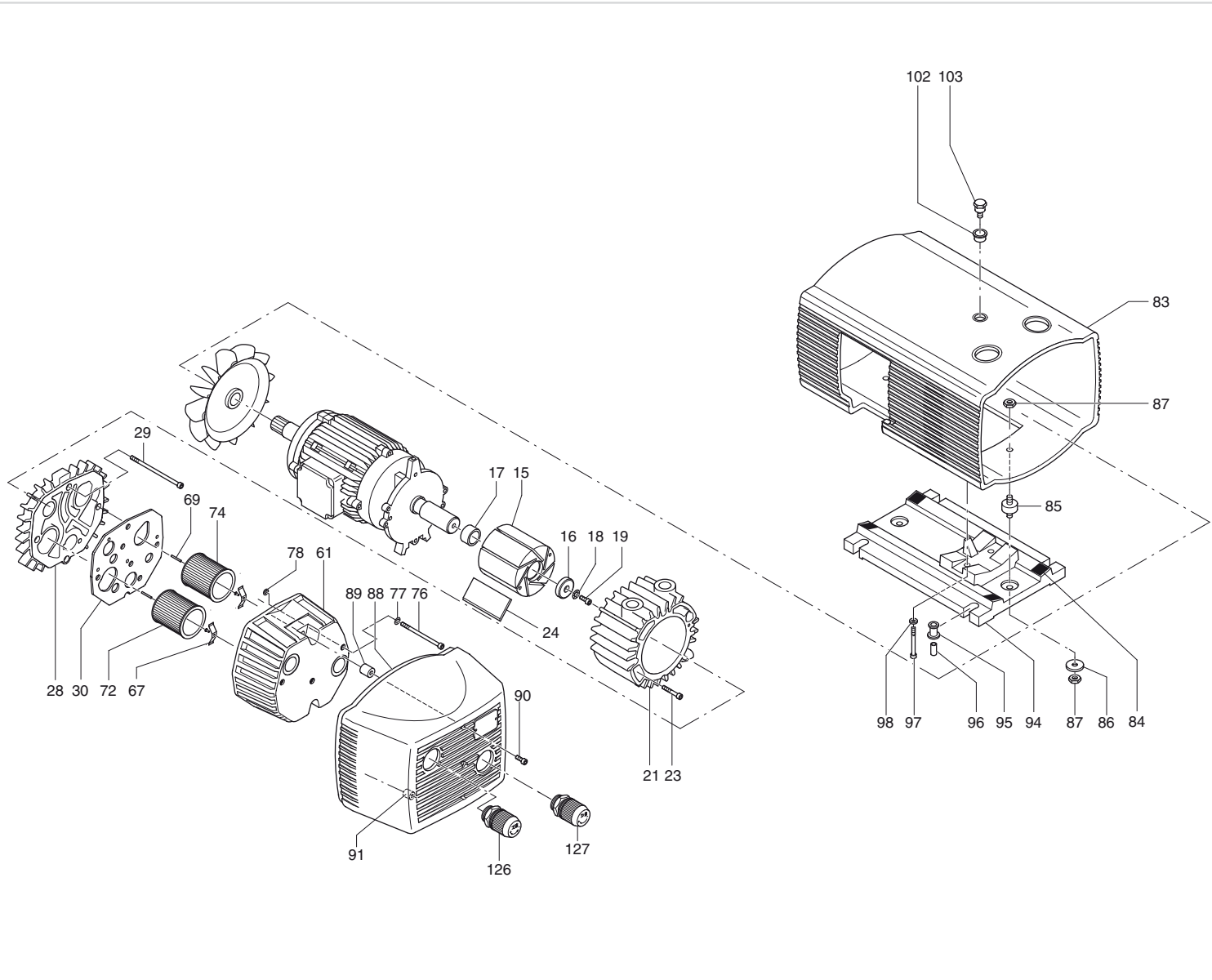
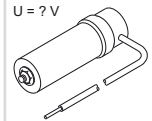



standard

T 4.10 DV (3~)

T 4.16 DV (3~)

optional
en option
opcionale
opcional

optional en option optionale opcional 	Variante(n) Modifications Variantes	Pos ²⁾	Bestell Nr. / Ident No. / No. Identification / No. Identificazione / No. De pedido		Beschreibung / Description / Designation / Designazione / Desripcion
					
T 4.10 DV (1~) T 4.16 DV (1~)	T 4.10 DV (1~)	5	964233 00000		WINKEL / BRACKET / SUPPORT / SUPPORTO / SOPORTE SECHSKANTSCHRAUBE / HEX-HEAD SCREW / VIS HEXAGONALE / VITE ESAGONALE / TORNILLO DE CABEZA HEXAGONAL MUTTER / NUT / ECROU / DADO / TUERCA KABEL / CABLE / CABLE / CAVO / CABLE T 4.10 DV HAUBE / PROTECTING HOOD / CARTER PROTECTEUR / CARTER DI PROTEZIONE / CAPERUZA T 4.16 DV HAUBE / PROTECTING HOOD / CARTER PROTECTEUR / CARTER DI PROTEZIONE / CAPERUZA
	T 4.16 DV (1~)	6	945204 00000		
		7	947102 00000		
		8	742002 40000		
		83	006802 27300		
		83	006802 27400	006800 27300	

²⁾ variantenabhängige Bauteile / variant-dependent components / composants variante-dependantes / componenti variante-dispendenti / componentes variante-dependientes